



 **kratki.pl**





*Tworzymy ciepłą atmosferę...*



## Oznaczenia stosowane w ulotce / Symbols used in catalogue / Die Bezeichnung im Katalog

### / Назначение используемые в каталоге / Description des symboles

---

-  Moc nominalna (kW) / Power rating (kW) / Nominalleistung (kW) / Мощность (кВт) / Puissance nominale (kW)
-  Zakres mocy grzewczej (kW) / Range of power rating (kW) / Leistungsbereich (kW) / Диапазон мощности нагрева (кВт) / Gamme de puissance de chauffage (kW)
-  Sprawność cieplna (%) / Efficiency (%) / Wirkungsgrad (%) / Тепловая мощность (%) / Rendement (%)
-  Średnica czopucha (mm) / Diameter (mm) / Rauchrohrdurchmesser (mm) / Диаметр дымохода (мм) / Tubage (mm)
-  Waga (kg) / Weight (kg) / Gewicht (Kilo) / Вес (Kr) / Poids (Kg)
-  Długość polan (mm) / Length of wood (mm) / Holzscheitslänge (mm) / Длина поленьев (мм) / Taille des bûches (mm)
-  Średnia moc z wody (kW) / The average power of the water (kW) / Durchschnittliche Leistung wasserseitig (kW) / Средняя мощность воды (кВт) / Puissance moyenne de l'eau (kW)
-  Material / Material / Material / Материал / Matériaux du corps de chauffe
-  szyba prosta / front glass / Glass gerade / Простая / verre frontal
-  bok lewy / left side glass / Seitenscheibe rechts / С левым стеклом / vitre à gauche
-  bok prawy / right side glass / Seitenscheibe links / С правым стеклом / vitre à droit
-  prawa - lewa / left and right side glass / Seitenscheibe rechts und links / Трехсторонняя / vitre à droit-gauche
-  przód i tył / back side (tunnel) glass / Scheibe vorne und hintere Zusatztür / Двухсторонняя / vitre double face
-  lewa i tył / left and back side glass / Seitenscheibe links und hintere Zusatztür / Трехсторонняя - стекло слева / double face et vitre à gauche
-  prawa i tył / right and back side glass / Seitenscheibe rechts und hintere Zusatztür / Трехсторонняя - стекло справа / double face et vitre à droit
-  prawa - lewa i tył / left, right and back side glass / Seitenscheibe rechts links und hintere Zusatztür / Четырехсторонняя / double face et vitre à gauche et à droite
-  pryzma / prismatic glass / Prismascheibe / Призматическое стекло / Vitre prismatique
-  panorama / panoramic glass / Panoramacheibe / Панорамное стекло / Vitre panoramique
-  gilotyna / lift up system / Schiebetür / Гильотина / Ouverture relevable
-  gilotyna przód i tył / double lift up system / Schiebetür vorne und hinten / Гильотина передняя и задняя / double face ouverture relevable

 LUX

 DECO

 szyby łączone bez szprosa - lewa / joined glass without holding iron brackets - left / zwei Scheibe ohne Sprosse - links / стекла соединены, без перемычки - стекло слева / vision gauche sans cadres

 szyby łączone bez szprosa - prawa / joined glass without holding iron brackets - right / zwei Scheibe ohne Sprosse - rechts / стекла соединены, без перемычки - стекло справа / vision droit sans cadres



 szyby łączone bez szprosa - prawa, lewa / joined glass without holding iron brackets - right, left / drei Scheibe ohne Sprosse - rechts/links / стекла соединены, без перемычки - стекло справа, стекло слева / vision gauche et droit sans cadres



 gilotyna - szyby łączone bez szprosa - prawa / lift up system - joined glass without holding iron brackets, right / Schiebetür - zwei Scheibe ohne Sprosse - rechts / Гильотина - стекла соединены, без перемычки, стекло справа / vision droit sans cadres ouvertur relevable

 gilotyna - szyby łączone bez szprosa - lewa / lift up system - joined glass without holding iron brackets, left / Schiebetür - zwei Scheibe ohne Sprosse - links / Гильотина - стекла соединены, без перемычки, стекло слева / vision gauche sans cadres ouvertur relevable

 Wkład kominkowy spełnia normy BlmschV 2 / Fireplace insert meets BlmschV 2 norms and regulations / Kamineinsatz erfüllt die BlmschV Stufe 2 / Каминная топка соответствует нормам BlmschV 2 / L'insert répond le BimSchV 2

 Kominek idealny do domów z rekuperatorami / Ideal for homes with heat recovery units / Der ideale Kamin zu den Häusern mit den Abhtzeverwerter / Идеально подходит для домов с энергосберегающими технологиями / Il camino ideale per le case passive

   Minimalne wymagane pole czynne krtek wylotowych / Recommended ventilation area of the air outlet grid / Mindest Luftdurchsatz von Abluftgitter / Рекомендуемая активная площадь (поле) решетки на выходе / Section de passage d'air minimal requise pour les grilles d'aeration de sortie

   Minimalne wymagane pole czynne krtek wlotowych / Recommended ventilation area of the air intake grid / Mindest Luftdurchsatz von Zuluftgitter / Рекомендуемая активная площадь (поле) решетки на входе / Section de passage d'air minimal requise pour les grilles d'aeration d'entree

### Wymiary: / Dimensions: / Masse: / Размер: / Dimensioni:

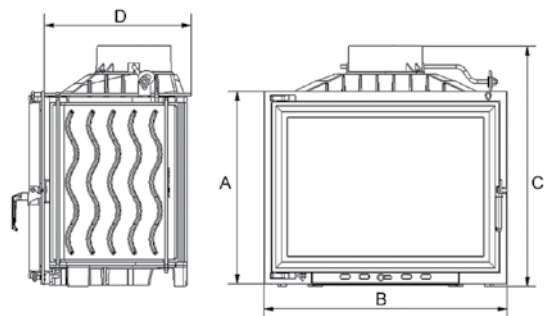

A x B x C x D

Podane wymiary dotyczą wkładów kominkowych i pieców wolnostojących z szybą prostą, wersja podstawowa.

These dimensions apply to fireplace inserts and free standing stoves with straight glass.

Die angegebenen Abmessungen sind für freistehenden Öfen und Kamineinsätzen mit Geradeglas.

Указанные размеры относятся к каминным топкам и отдельно стоящим печам с прямым стеклом

Les dimensions indiquées sont des inserts et poêles avec du verre simple, version de base.



Antek

491x600x622x334



kW 10 <kW< 6-13 62 180 94 330  
 $\geq 700 \text{ cm}^2$   
 $\geq 500 \text{ cm}^2$

Wiktor

515x738x645x384



kW 14 <kW< 7-18 70 200 110 450  
 $\geq 900 \text{ cm}^2$   
 $\geq 700 \text{ cm}^2$

Maja

491x600x701x360



kW 11 <kW< 5,7-14,5 75 200 115 330  
 $\geq 900 \text{ cm}^2$   
 $\geq 700 \text{ cm}^2$

Zuzia

515x652x810x442



kW 16 <kW< 8-22 70 200 149 500  
 $\geq 1000 \text{ cm}^2$   
 $\geq 800 \text{ cm}^2$

Eryk

515x652x644x383



kW 12 <kW< 8-16 70 200 104 350  
 $\geq 900 \text{ cm}^2$   
 $\geq 700 \text{ cm}^2$

Felix

607x750x737x384







kW 16 <kW< 8-22 73 200 125 450  
 $\geq 1000 \text{ cm}^2$   
 $\geq 800 \text{ cm}^2$



### Oliwia

515x738x810x443





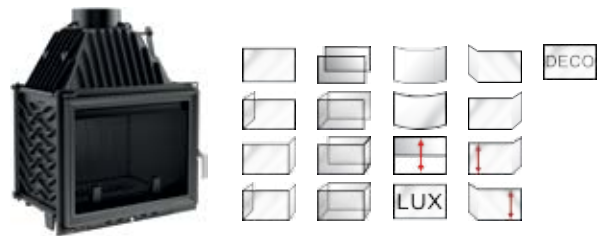

kW 18   
 <kW< 9-23   
  79   
  200   
  162   
  500   
 ≥ 1000 cm<sup>2</sup>  
≥ 800 cm<sup>2</sup>

### Amelia

607x750x902x443,5





kW 21   
 <kW< 11,5-29   
  79   
  200   
  183   
  500   
 ≥ 1000 cm<sup>2</sup>  
≥ 800 cm<sup>2</sup>

### Maja Wieża

1118x759x1118x365







kW 15   
 <kW< 7-19,5   
  71   
  200   
  155   
  330   
 ≥ 900 cm<sup>2</sup>  
≥ 700 cm<sup>2</sup>

## Zuzia Eko

543x652x833x455



**kW** 16   **<kW<** 8-22    70    200    168    500    $\geq 1000 \text{ cm}^2$   
 $\geq 800 \text{ cm}^2$

## Amelia Eko

635x750x925x455



**kW** 18   **<kW<** 12-25    71    200    196    500    $\geq 1000 \text{ cm}^2$   
 $\geq 800 \text{ cm}^2$

## Natala

903x764x1096x362



**kW** 12   **<kW<** 9-15    72    180    142    500    $\geq 900 \text{ cm}^2$   
 $\geq 700 \text{ cm}^2$



Mila

606x1132x1034x449



kW 16  
 <kW 8-22  
 71  
 200  
 181  
 700  
  $\geq 1000 \text{ cm}^2$   
 $\geq 800 \text{ cm}^2$

Jaś

450x676x543x306



kW 7  
 <kW 3,3-9,9  
 71  
 150  
 61  
 400  
  $\geq 700 \text{ cm}^2$   
 $\geq 500 \text{ cm}^2$

Ala

828x612x1480x594



kW 11,4  
 <kW 6-14  
 75  
 200  
 151  
 350  
  $\geq 900 \text{ cm}^2$   
 $\geq 700 \text{ cm}^2$

Atena

378x768x634x417



kW 12  
 <kW 8-16  
 75  
 150  
 90  
 350  
  $\geq 900 \text{ cm}^2$   
 $\geq 700 \text{ cm}^2$

Basia

625x900x759x487



kW 12  
 <kW 6,8-17  
 70  
 200  
 128  
 500  
  $\geq 900 \text{ cm}^2$   
 $\geq 700 \text{ cm}^2$

Zibi

458x765x876x537



kW 11  
 <kW 4,5-14  
 80  
 180  
 150  
 400  
  $\geq 900 \text{ cm}^2$   
 $\geq 700 \text{ cm}^2$







**Blanka**

610x450x1009x450



kW  
8

<kW<  
7,5-11

78

160

117

300

≥ 700 cm<sup>2</sup>

≥ 500 cm<sup>2</sup>

**Blanka 670/570**

576x676x974,5x453



kW  
11

<kW<  
7,1-14,5

81

180

148

500

≥ 900 cm<sup>2</sup>

≥ 700 cm<sup>2</sup>

**Blanka 910**

559,5x910x956,5x453



kW  
16

<kW<  
7,5-21,5

83

200

185

500

≥ 1000 cm<sup>2</sup>

≥ 800 cm<sup>2</sup>

Frnek

540x700x968x476

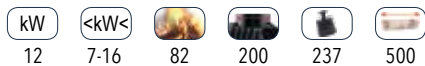

≥ 900 cm<sup>2</sup>

≥ 700 cm<sup>2</sup>

MBO

510x830x1440x473

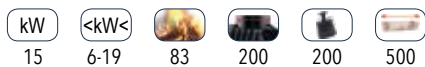

≥ 900 cm<sup>2</sup>

≥ 700 cm<sup>2</sup>



MBM

450x703x1261x475

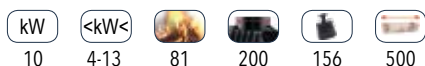

≥ 700 cm<sup>2</sup>

≥ 500 cm<sup>2</sup>





### Nadia 8

969,5x484x1211x445

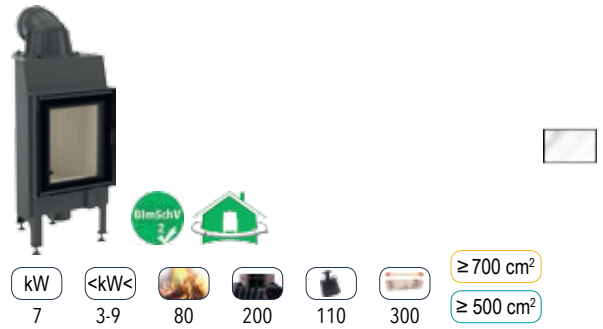

### Nadia 10

969,5x684x1211x445

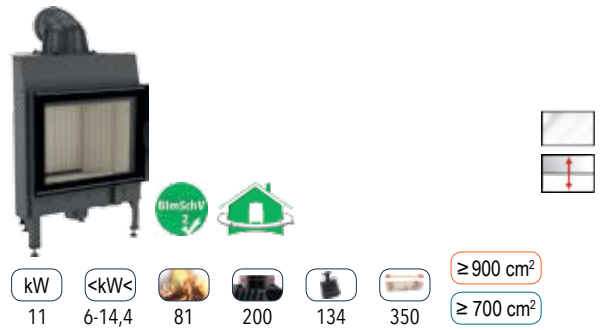

### Nadia 12

606x1132x1034x449



Nadia 13

640x834x1331x418



kW

13

<kW<

7-16



82



200



160



400

≥ 900 cm<sup>2</sup>

≥ 700 cm<sup>2</sup>

Nadia 14

920,5x979x1162x445

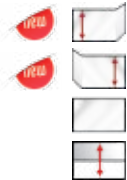

kW

14

<kW<

6,5-17



80



200



177



500

≥ 900 cm<sup>2</sup>

≥ 700 cm<sup>2</sup>



**Antek/PW**

491x600x677x380

**Wiktor/PW**

515x738x703x421

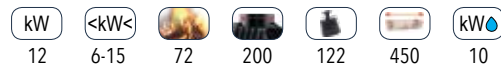
**Eryk/PW**

515x652x701x421

**Felix/PW**

607x750x792x421

**Maja/PW**

491x600x677x390

**Zuzia/PW**

515x652x869x471

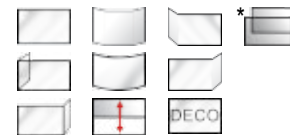

\*tylko w opcji 19 kW / \*only in 19kW option / \*nur 19kW erreichbar / \*доступные только в опции 19кВт / \*isponibles uniquement en modèle 19kW







**Oliwia/PW**

515x738x868x471



kW <kW< kW  
 17 / 22 8-23 / 11-29 75 / 75 200 / 200 171 / 181 500 / 500 13 / 18

**Amelia/PW**

607x750x960x471



kW <kW< kW  
 24 / 28 11-30 / 13-35 78 / 75 220 / 220 187 / 200 500 / 500 20 / 24

**Natala/PW**

903x764x1118x437



kW <kW< kW  
 14 7-14 76 180 156 500 13

\*\*tylko w opcji 22kW, \*\*\*24kW / \*\*only in 22kW option, \*\*\*24kW / \*\*nur 22kW erreichbar, \*\*\*24kW /  
 \*\*доступные только в опции 22кВт, \*\*\*24кВт / \*\*isponibles uniquement en modèle 22kW, \*\*\*24kW





**Mila/PW**

606x1132x1034x448







 kW	 <kW<					 kW
24	11-30	78	200	213	700	12

**Zuzia NP**

515x652x1138x471



 kW	 <kW<					 kW
24	18-28	81	200	217	500	21

**Zuzia DIN DECO**

520x652x869x495



 kW	 <kW<					 kW
11	11-15	88,4	200	200	500	7

Nadia/PW

512x650x1390416



kW

11

<kW<

5-13,5



82



200



192



350

kW

6





Aquario M8

Aquario M12



Aquario Z10

Aquario Z14



Aquario O12







Aquario O16



Aquario A14

Aquario A18



	AQUARIO /M/8/W	AQUARIO /M/12/W	AQUARIO /Z/10/W	AQUARIO /Z/14/W	AQUARIO /O/12/W	AQUARIO /O/16/W	AQUARIO /A/14/W	AQUARIO /A/18/W
 kW	8	12	9	12	12	16	14	18
 kW	5,5	8,1	7,1	10,6	8,4	10,8	9,8	12,5
 <kW	5-10	8-14	5-11	7-14	8-16	8-16	8-16	10-18
	180	180	200	200	200	200	200	200
	81,7	86,7	82,5	86	83,1	84,4	84,3	86,5
	213	236	250	283	280	312	290	331
	450	450	550	550	550	550	500	500

**Wymiary: / Dimensions: / Masse: / Размер: / Dimensioni:**

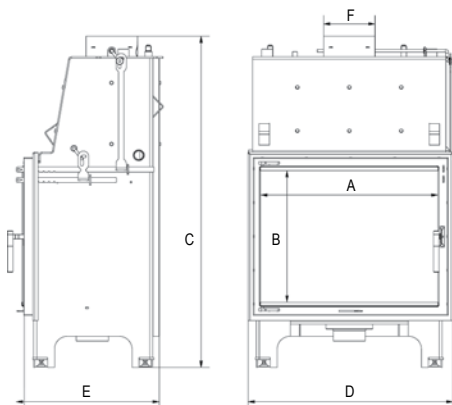

	A	B	C	D	E	F
AQUARIO/M/8/W	464	334	1001	637	442	ø180
AQUARIO/M/12/W	464	334	1201	637	442	ø180
AQUARIO/Z/10/W	519	358	1181	692	524	ø200
AQUARIO/Z/14/W	519	358	1335	692	524	ø200
AQUARIO/O/12/W	605	358	1181	778	524	ø200
AQUARIO/O/16/W	605	358	1335	778	524	ø200
AQUARIO/A/14/W	605	448	1273	790	524	ø200
AQUARIO/A/18/W	605	448	1427	790	524	ø200





### Piecyk kaflowy Blanka

610x715x1365x598



kW  
8

<kW<  
7,5-11

78

160

300

300

### Wk440

44x650x748x374



kW  
6,5

<kW<  
3-9,3

80

130

130

350

### Koza AB/S/K

604x515x1052x410



kW  
8

<kW<  
5,5-10,5

78

150

116

250

Koza AB/S/N/K

604x528x1086x418



kW

8

<kW<

5,5-10,5



78



150



107



250





### Koza K5

509x452x628x406



7



5,5-9



76



130



150



118



250

### Koza K6

500x578x630x490



8



7-11



76



130



150



120



350

### Koza K6/W

500x578x630x500



8



5,4x10,5



76



130



120



350



2



**Koza K7**

410x536x557x413

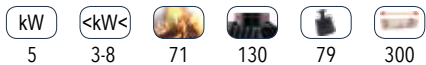
**Koza K8**

491x666x629x382

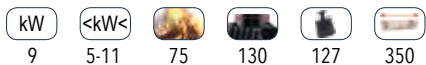
**Koza K9**

529x766x660x546

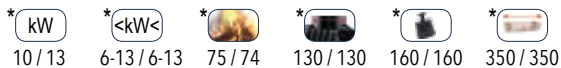

\*paliwo: drewno / węgiel \*fuel: wood / coal \*fuel: holz / kohle \*топливо: дерево / уголь \*combustible: bois / charbon



**Koza K9/W**

529x766x660x556

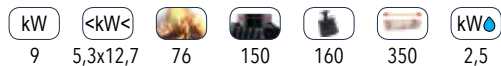
**Koza S10 Simple**

704x472x847x395

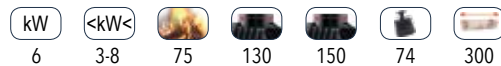
**Koza K10**

508x362x685x548

**Koza S10 Barril**

704x510x848x395

**Koza Alicja/PW**

845x662x991x396

**Koza S10 Orasa**

510x540x860x389



Koza AB

604x515x1052x410

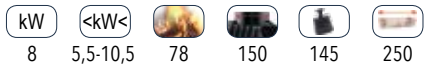

Koza AB/S

604x515x1052x410

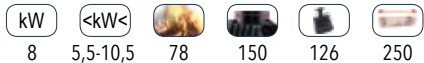

Koza AB/S/N

604x528x1086x418

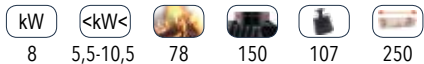

VENUS



wkrótce / soon / bald / скоро / bientôt

Malowane / Painted / Lackiert / Окрашенные / Peintes

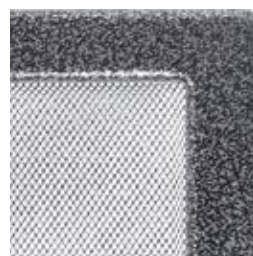



Powlekane / Covered / Beschichtet / С покрытием / Grilles d'aération revêtues



Galwanizowane / Galvanized / Galvanisiert / Гальванизованные / Galvanisées





ABC



Wymiary: / Dimensions: / Masse: / Размер: / Dimensioni:  
 17x17, 17x30, 17x37, 17x49, 22x22, 22x30, 22x37, 22x45 cm/cm

Pole czynne kratki: / Air flow in: / Luftdurchsatz: / Площадь потока воздуха: / Surface de passage (d'une grille d'aeration)  
 72,9; 144,3; 180,3; 236,5; 126,5; 184,6; 239,2; 301,8 cm<sup>2</sup>/cm<sup>2</sup>

Tunel / Tunnel / Tunnel / Туннель / Grilles d'aération Tunel



Wymiary: / Dimensions: / Masse: / Размер: / Dimensioni:  
 6x40, 6x60, 6x80, 6x100 cm/cm

Pole czynne kratki: / Air flow in: / Luftdurchsatz: / Площадь потока воздуха: / Surface de passage (d'une grille d'aeration)  
 112, 172, 232, 292 cm<sup>2</sup>/cm<sup>2</sup>



17x17, 22x22 cm/cm

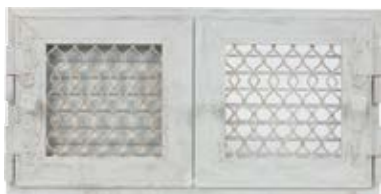

17x17, 22x22 cm/cm



17x17, 22x22 cm/cm



17x17, 22x22 cm/cm



28x33 cm/cm



35x44 cm/cm



30x30 cm/cm



22x44 cm/cm



Mila Tunel / Mila Tunnel / Mila Tunnel / Mila Туннель / Grilles d'aération Mila Tunel



Wymiary: / Dimensions: / Masse: / Размер: / Dimensioni:  
12x90, 14x113,2 cm/cm

Luft



Wymiary: / Dimensions: / Masse: / Размер: / Dimensioni:  
6x40, 6x60, 6x80, 6x100, 9x40, 9x60, 9x80, 9x100 cm/cm

Pole czynne kratki: / Air flow in: / Luftdurchsatz: / Площадь потока воздуха: / Surface de passage (d'une grille d'aération)  
112, 172, 232, 292, 222, 342, 462, 582 cm<sup>2</sup>/cm<sup>2</sup>

Luft narożna / Corner grids/Lüftungsgitter Eckig/Решетка Угловая / Grille d'aération blanche angulaire Luft



Dostępne kolory: biała, kremowa, grafitowa, czarna  
Available in colors: white, cream, graphite, black  
Verfügbare Farben: weiß, cremefarbig, graphit, schwarz  
Доступные цвета: белая, бежевая, графитовая, чёрная  
Couleurs disponibles: blanc, crème, graphite, noir

Wymiary: / Dimensions: / Masse: / Размер: / Dimensioni:  
56x56x9, 76,6x54,7x9, 54,7x76,6x9, 6x56x6, 76,6x54,7x6, 54,7x76,6x6 cm/cm

Pole czynne kratki: / Air flow in: / Luftdurchsatz: / Площадь потока воздуха: / Surface de passage (d'une grille d'aération)  
504, 612, 612, 264, 321, 321 cm<sup>2</sup>/cm<sup>2</sup>

Fresh





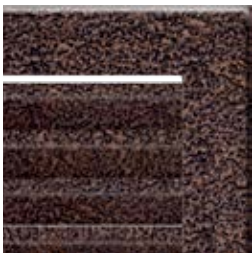
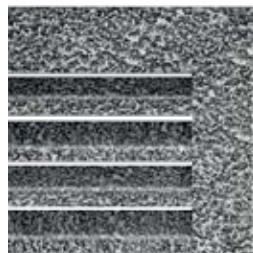
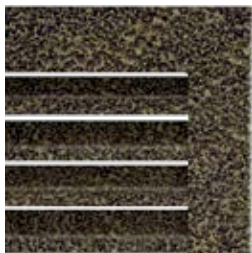

Wymiary: / Dimensions: / Masse: / Размер: / Dimensioni:  
17x17, 17x30, 17x37, 17x49, 17x70 cm/cm

Pole czynne kratki: / Air flow in: / Luftdurchsatz: / Площадь потока воздуха: /  
Surface de passage (d'une grille d'aeration)  
103, 215, 275, 369, 558 cm<sup>2</sup>/cm<sup>2</sup>

Kratka podlogowa / Floor grids / Fußbodengitter / Напольная решетка /  
Grille de plancher

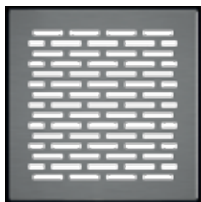

Wymiary: / Dimensions: / Masse: / Размер: / Dimensioni:  
164x94, 162x162, 212x102, 414x104, 613x103 mm/mm

Pole czynne kratki: / Air flow in: / Luftdurchsatz: / Площадь потока воздуха: /  
Surface de passage (d'une grille d'aeration)  
40, 60, 45, 100, 185 cm<sup>2</sup>/cm<sup>2</sup>



Okrągła fi / Round fi / Rund fi / Круглая fi / Ronde fi



Wymiary: / Dimensions: / Masse: / Размер: / Dimensioni:  
10; 12,5; 15 cm/cm

Pole czynne kratki: / Air flow in: / Luftdurchsatz: / Площадь потока воздуха: / Surface de passage (d'une grille d'aération)  
60, 70, 80 cm<sup>2</sup>/cm<sup>2</sup>

Kratki na zamówienie / Grids made for order / Lüftungsgitter auf Bestellung / Решётки под заказ / Grilles d'aération sur commande

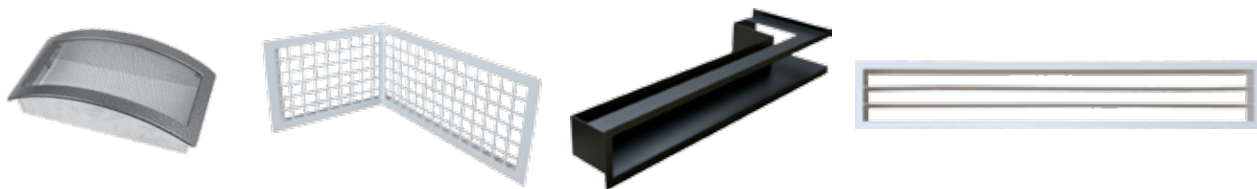

Wykonujemy kratki na zamówienie według indywidualnego projektu klienta. Kratki dostępne są według standardowych kolorów z naszej oferty.

We produce grids according to customer individual project. Grids are available according to the standard colors we offer.

Wir fertigen Lüftungsgitter auf Bestellung. Diese Lüftungsgitter sind in Standardfarben unseres Angebots erhältlich.

Производим решётки под заказ по индивидуальному проекту клиента. Доступные решётки в соответствии со стандартными цветами.

Nous réalisons des grilles d'aération à la demande, selon le projet individuel du client et selon les couleurs standards disponibles dans notre offre.

Wymiar	Wymiar kieszeni (mm)	Wymiar kratki prostych (mm)	Wymiar kratki prostych z żaluzją (mm)	Kratka Diana	Kratka Diana z żaluzją	Kratka Rustyk	Kratka Rustyk z żaluzją	Kratka Oskar	Kratka Oskar z żaluzją	Pole czynne kratki (cm <sup>2</sup> )
Name	Pocket dimensions (mm)	Dimensions of simple grids (mm)	Dimensions of simple grids with blinds (mm)	Diana grid	Diana grid with blind	Rustical grid	Rustical grid with blind	Oskar grid	Oskar grid with blind	Air flow in (cm <sup>2</sup> )
Name	Maße der einfachen Lüftungsgitter (mm)	Maße der einfachen Lüftungsgitter (mm)	Maße der einfachen Lüftungsgitter mit Jalousien (mm)	Lüftungsgitter Diana	Lüftungsgitter Diana mit Jalousie	Lüftungsgitter rustikal	Lüftungsgitter rustikal mit Jalousie	Lüftungsgitter Oskar	Lüftungsgitter Oskar mit Jalousie	Luftdurchsatz (cm <sup>2</sup> )
Название	Размер решеток (мм)	Размер решеток с жалюзи (мм)	Размер решеток с жалюзи (мм)	Решетка Diana с жалюзи	Решетка Diana с жалюзи	Решетка рустик	Решетка рустик с жалюзи	Решетка Oskar	Решетка Oskar с жалюзи	Площадь потока воздуха (см <sup>2</sup> )
Dimensions	Dimensions du cadre à encastrer (mm)	Dimensions des grilles d'aération simples (mm)	Dimensions des grilles d'aération à volets mobiles (mm)	Grille d'aération Diana	Grille d'aération Diana à volets mobiles	Grille d'aération Rustique	Grille d'aération Rustique à volets mobiles	Grille d'aération Oskar	Grille d'aération Oskar à volets mobiles	surface de passage (d'une grille d'aération)
11x11	86x86	106x106	-	116x116	-	116x116	-	116x116	-	36
11x17	86x152	106x170	-	116x175	-	116x175	-	116x175	-	75
11x24	86x217	106x236	-	116x245	-	116x245	-	116x245	-	117
11x32	86x287	106x307	-	116x316	-	116x316	-	116x316	-	156
11x42	86x397	106x417	-	116x425	-	116x425	-	116x425	-	222
17x17	152x152	170x170	170x170	177x177	177x177	177x177	177x177	177x177	177x177	144
17x30	152x275	170x301	170x301	177x301	177x301	177x301	177x301	177x301	177x301	300
17x37	152x351	170x370	170x370	177x377	177x377	177x377	177x377	177x377	177x377	384
17x49	152x456	170x481	170x481	177x483	177x483	177x483	177x483	177x483	177x483	516
22x22	200x200	220x220	220x220	220x220	220x220	220x220	220x220	220x220	220x220	289
22x30	200x275	220x300	220x300	-	-	-	-	-	-	425
22x37	200x351	220x370	220x370	-	-	-	-	-	-	544
22x45	200x426	220x450	220x450	-	-	-	-	-	-	680



Bezpieczeństwo  
Produkcja  
kontrolowana



www.tuv.com  
ID 0000044536

Nasze biokominki posiadają certyfikat bezpieczeństwa TÜV  
Our biofireplaces acquired a TÜV safety certificate  
Unsere Biokamine sind TÜV Rheinland zertifiziert  
Наши биокамины сертифицированы TÜV  
Nos biocheminées sont certifiés par le TÜV

Wymiary / Dimensions / Masse / Размер / Dimensiuni:

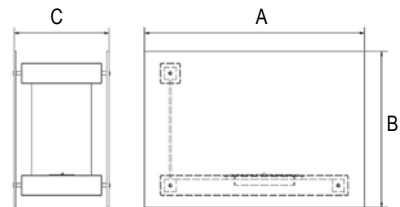
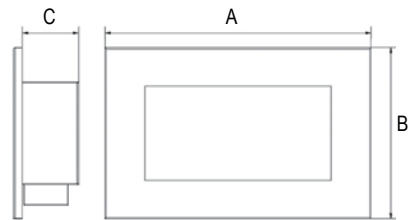

LINATE, HOTEL, HOTEL MINI, FOXTROT,  
HOTEL KRZAK, HOTEL MINI KRZAK

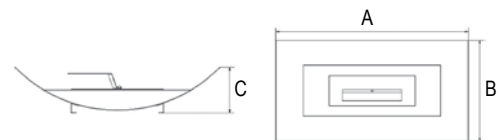

MISA, MISA MINI, INDIA, INDIA MINI, INDIA MAX, KILO



Biokominek dostępny w wersji z szybą  
Biofireplace available with glass as an option  
Biokamin erhältlich optional mit dem Schutzglas  
Био-камин доступен в версии со стеклом  
Bio-cheminée disponible avec verre

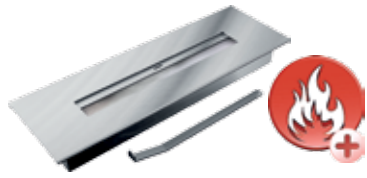
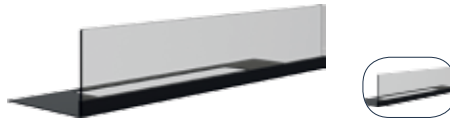

Nasze Biokominki wyposażone są w bezpieczny bio - pojemnik

Bezpieczny pojemnik biokominka z wkładem absorbującym/chłonny to nowe rozwiązanie zastosowane w pojemnikach do biokominków. Pozwala on na znaczne zmniejszenie zużycia paliwa, a przede wszystkim wyklucza ryzyko wylania/rozlania się paliwa, nawet w razie przypadkowego przewrócenia się biokominka z palącym się paliwem w pojemniku.

Our Biofireplaces are equipped in safe bio container.

Safety container of bio-fireplace with absorbing material inside is a new solution used in bio containers. It allows for a significant reduction in fuel consumption in case of accidental tipping biofireplace, and above all eliminates any risk of spillage of fuel in the event of accidental overturning of bio-fireplace with the the burning fuel in the container.

Unsere Biokamine sind mit einem sicheren Behälter ausgestattet.

Sicherer Behälter des Biokamins mit einem Keramikschwamm, der sich durch Saugeigenschaften auszeichnet, ist eine neue Lösung in den Bio-Kaminen. Die Anwendung des Keramikschwamms lässt einerseits den Verbrauch von Bio-Brennstoff sinnvoll reduzieren, vor allem aber schützt vor dem Verschütten des Brennstoffs außerhalb des Behälters, auch wenn er während des Brennprozesses umkippt.

Наши биокамины оснащены в безопасный био - контейнер.

Безопасный контейнер для биокамина с абсорбирующим материалом - это новое решение для биоконтейнеров, которое позволяет уменьшить потребление биотоплива и исключает риск разлития этого топлива даже при случайном опрокидывании биокамина во время горения.

Bio-cheminée avec le conteneur sécuritaire.

Le contenant sécuritaire du bio-cheminée avec contribution absorbant, c'est nouvelle solution utilisée dans des conteneurs pour les bio-cheminée.

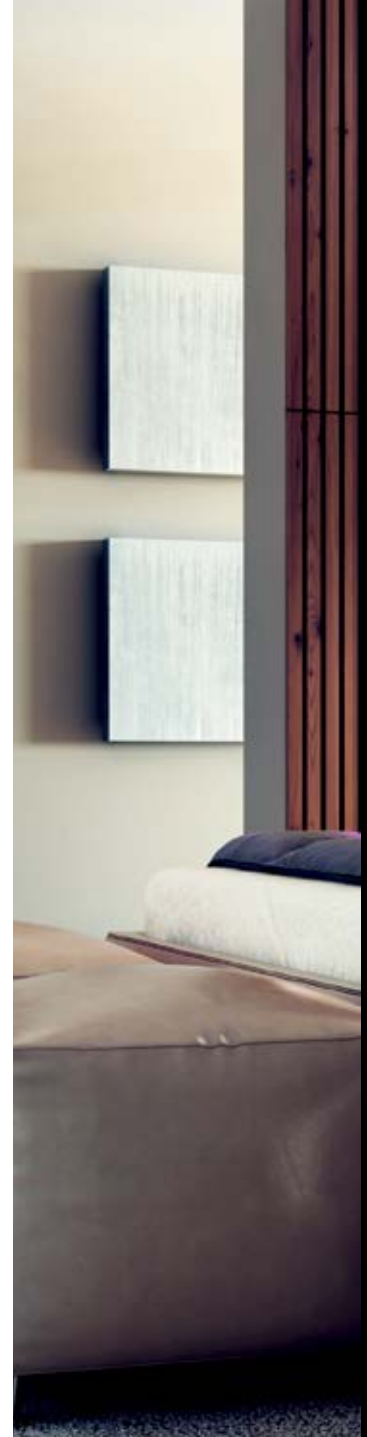

Il permet une réduction significative de la consommation de carburant, et surtout à écarter le risque de fuite / déversement de carburant, même en cas de renversement accidentel de la bio-cheminée avec le carburant brûlant dans le conteneur.



**Alpha**

800x590x174





17   stal czarna malowana / black painted steel / Schwarzstahl gestrichen / черная сталь с окраской / acier noir peint

**Charlie**

880x510x174





20   stal czarna malowana / black painted steel / Schwarzstahl gestrichen / черная сталь с окраской / acier noir peint

**Bravo**

900x652x174





23,5   stal czarna malowana / black painted steel / Schwarzstahl gestrichen / черная сталь с окраской / acier noir peint

**Charlie 2**

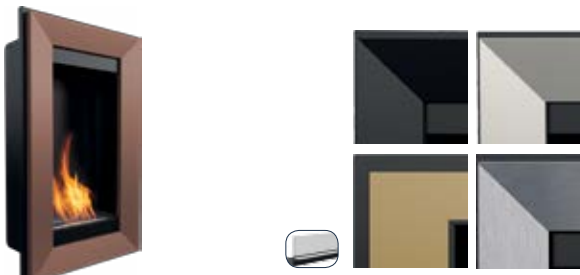
460x780x174





14,5   stal czarna malowana / black painted steel / Schwarzstahl gestrichen / черная сталь с окраской / acier noir peint

**Bravo 2**

900x650x174





23   stal czarna malowana / black painted steel / Schwarzstahl gestrichen / черная сталь с окраской / acier noir peint

**Delta Flat**

900x400x120



13,2   stal czarna malowana / black painted steel / Schwarzstahl gestrichen / черная сталь с окраской / acier noir peint



Bezpečnostní  
Produkce  
kontrolována  
[www.tuv.com](http://www.tuv.com)  
ID 900044536



### Delta

600x400x142



6,8



stal czarna malowana / black painted steel  
/ Schwarzstahl gestrichen / черная сталь  
с окраской / acier noir peint

### Delta 2

900x400x142



8,4



stal czarna malowana / black painted steel  
/ Schwarzstahl gestrichen / черная сталь  
с окраской / acier noir peint

### Delta 3

1200x 400x142



13,5



stal czarna malowana / black painted steel / Schwarzstahl  
gestrichen / черная сталь с окраской / acier noir peint





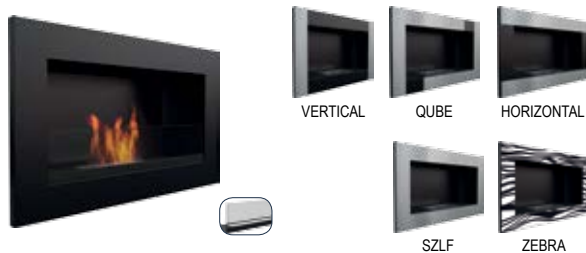

**Golf**

648x374x144





4,4   stal czarna malowana / black painted steel / Schwarzstahl gestrichen / черная сталь с окраской / acier noir peint

**Foxtrot**

360x702x290





15   stal czarna malowana / black painted steel / Schwarzstahl gestrichen / черная сталь с окраской / acier noir peint

**Galina**

354x218x142





4   stal czarna malowana, szkło / black painted steel, glass / Glas, Holz / черная сталь с окраской, стекло / acier noir peint, verre

**Hotel Krzak**

808x600x488





12   stal czarna malowana / black painted steel / Schwarzstahl gestrichen / черная сталь с окраской / acier noir peint

**Mike**

854x510x211





 Glass system - dodatkowa opcja  
System glass - additional option  
Glass-System - zusätzliche Option  
Двойное стекло - дополнительный выбор  
Système double vitre - option supplémentaire

40   stal czarna malowana, szkło / black painted steel, glass / Glas, Holz / черная сталь с окраской, стекло / acier noir peint, verre

**Hotel Mini Krzak**

564x488x372



6   stal czarna malowana / black painted steel / Schwarzstahl gestrichen / черная сталь с окраской / acier noir peint



Hotel

700x400x334

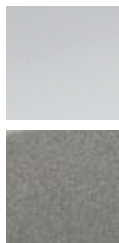
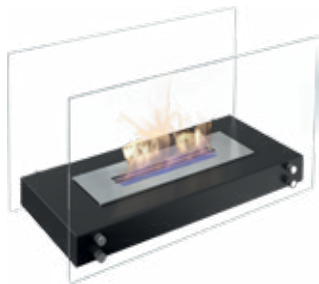

15,5



stal czarna malowana, szkło / black painted steel, glass  
/ Glas, Holz / черная сталь с окраской, стекло / acier  
noir peint, verre

India

490x215x85



4



stal czarna malowana / black painted steel / Schwarzstahl  
gestrichen / черная сталь с окраской / acier noir peint

Hotel Mini

390x250x234

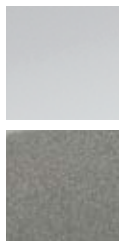
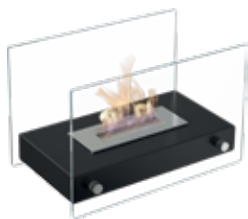

6



stal czarna malowana, szkło / black painted steel, glass  
/ Glas, Holz / черная сталь с окраской, стекло / acier  
noir peint, verre

India Mini

340x155x70



2



stal czarna malowana / black painted steel / Schwarzstahl  
gestrichen / черная сталь с окраской / acier noir peint

Kilo

590x350x85



7



stal czarna malowana, stal szlifowana / black painted  
steel, inox tainless steel / Schwarzstahl gestrichen, Edel-  
stahl / черная сталь с окраской, нержавеющей сталь /  
tôle noire, tôle poncée

India Max

670x247x100



7



stal czarna malowana / black painted steel / Schwarzstahl  
gestrichen / черная сталь с окраской / acier noir peint

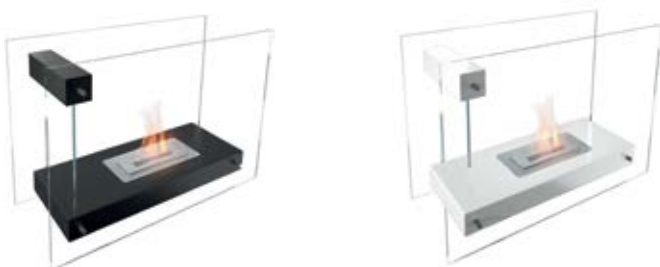

 61  fornir, szkło / veneer, glass / Glas, Holz / Стекло, дерево / bois de placage, verre

Pozostałe kolory LINATE dostępne na zamówienie: / Other colours LINATE available on request: / Weitere Furniervarianten erhältlich auf Bestellung: / Варианты текстуры под заказ: / Autres couleurs disponibles sur commande:

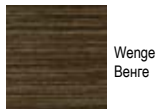
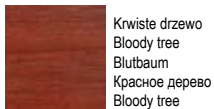
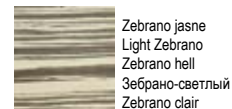
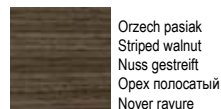
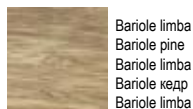
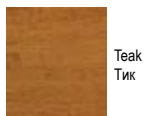
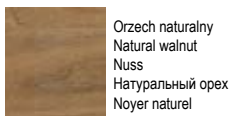

Słowo oraz kolory forniru widoczne na zdjęciach mogą nieznacznie odbiegać od okleiny znajdującej się w sprzedaży. Przedstawioną kolorystykę należy traktować jako przybliżoną.

Jars and colors of veneer may be slightly different from the dashboard located in current sale. Colouring set out should be considered as an approximate.

Die Maserungen und Farben der Portalrahmen aus Furnier auf den Fotos können von dem gelieferten Produkt etwas abweichen. Die dargestellten Farben sollte man als Beispiel betrachten.

Варианты текстуры, показанные на фотографиях, могут незначительно отличаться от реальной. Их следует рассматривать как приблизительные.

Les cernes de bois et les couleurs sur les photos de cadres de placage peuvent légèrement diverger du placage en vente. Photos à titre indicatif seulement.

Juliet

1800x650x142



38



stal czarna malowana, stal szlifowana / black painted steel, inox tainless steel / Schwarzstahl gestrichen, Edelstahl / черная сталь с окраской, нержавеющей сталь / tôle noire, tôle poncée

Juliet 1500

1500x650x142



27



stal czarna malowana, stal szlifowana / black painted steel, inox tainless steel / Schwarzstahl gestrichen, Edelstahl / черная сталь с окраской, нержавеющей сталь / tôle noire, tôle poncée

Juliet 1100

1100x650x142



21



stal czarna malowana, stal szlifowana / black painted steel, inox tainless steel / Schwarzstahl gestrichen, Edelstahl / черная сталь с окраской, нержавеющей сталь / tôle noire, tôle poncée





Lima

1000x700x197



22,6



stal czarna malowana, stal szlifowana / black painted steel, inox tainless steel / Schwarzstahl gestrichen, Edelstahl / черная сталь с окраской, нержавеющая сталь / tôle noire, tôle poncée

Mila

1409x764x222



23



stal czarna malowana, stal szlifowana / black painted steel, inox tainless steel / Schwarzstahl gestrichen, Edelstahl / черная сталь с окраской, нержавеющая сталь / tôle noire, tôle poncée

Quad

685x534x185



11



stal czarna malowana / black painted steel / Schwarzstahl gestrichen / черная сталь с окраской / acier noir peint



VERTICAL



HORIZONTAL



QUBE



SZLIF

Quebec

1150x398x295



45



stal czarna malowana / black painted steel / Schwarzstahl  
gestrichen / черная сталь с окраской / acier noir peint

Oscar

900x630x190,5



19



stal czarna malowana, szkło / black painted steel, glass  
/ Glas, Holz / черная сталь с окраской, стекло / acier  
noir peint, verre

Af

779x551x260



21



stal czarna malowana, stal szlifowana / black painted steel,  
inox tainless steel / Schwarzstahl gestrichen, Edelstahl /  
черная сталь с окраской, нержавеющей сталь / tôle noire,  
tôle poncée





**Misa**

717x400x171



8,5



stal czarna malowana / black painted steel / Schwarzstahl gestrichen / черная сталь с окраской / acier noir peint

**Misa Mini**

470x260x130



4



stal czarna malowana / black painted steel / Schwarzstahl gestrichen / черная сталь с окраской / acier noir peint

**Papa**

650x900x143



12



stal czarna malowana / black painted steel / Schwarzstahl gestrichen / черная сталь с окраской / acier noir peint



### Papa Morpho

650x900x143



12,5



stal czarna malowana, stal szlifowana / black painted steel, inox  
tainless steel / Schwarzstahl gestrichen, Edelstahl / черная  
сталь с окраской, нержавеющей сталь / tôle noire, tôle poncée

### Papa Manhattan

650x900x143



13,5



stal czarna malowana, stal szlifowana / black painted steel, inox  
tainless steel / Schwarzstahl gestrichen, Edelstahl / черная  
сталь с окраской, нержавеющей сталь / tôle noire, tôle poncée

### Papa Smerf

650x900x143



12,7



stal czarna malowana, stal szlifowana / black painted steel, inox  
tainless steel / Schwarzstahl gestrichen, Edelstahl / черная  
сталь с окраской, нержавеющей сталь / tôle noire, tôle poncée



**Romeo**

359x1135,5x209



19

stal czarna malowana, stal szlifowana, szkło / black painted steel, inox tainless steel, glass / Schwarzstahl gestrichen, Edelstahl, Glas / черная сталь с окраской, нержавеющая сталь, стекло / tôle noire, tôle poncée, verre

**Sierra**

408x1700x405



48,5

stal czarna malowana, MDF biały / black painted steel, MDF white / Schwarzstahl gestrichen, MDF weiß / черная сталь с окраской, MDF белый / acier noir peint, MDF blanche

**Legionis**

1215x1152x342



85

stal czarna malowana, MDF biały / black painted steel, MDF white / Schwarzstahl gestrichen, MDF weiß / черная сталь с окраской, MDF белый / acier noir peint, MDF blanche

**October**

1180x940x330



56

stal czarna malowana, MDF biały / black painted steel, MDF white / Schwarzstahl gestrichen, MDF weiß / черная сталь с окраской, MDF белый / acier noir peint, MDF blanche

**November**

1200x1035x295



52

stal czarna malowana, MDF biały / black painted steel, MDF white / Schwarzstahl gestrichen, MDF weiß / черная сталь с окраской, MDF белый / acier noir peint, MDF blanche

**February**

1105x962x295



54

stal czarna malowana, MDF biały / black painted steel, MDF white / Schwarzstahl gestrichen, MDF weiß / черная сталь с окраской, MDF белый / acier noir peint, MDF blanche

December

1262x1071x325



64

stal czarna malowana, MDF biały / black painted steel,  
MDF white / Schwarzstahl gestrichen, MDF weiß / черная  
сталь с окраской, MDF белый / acier noir peint, MDF  
blanche

January

1067x1066x252



52

stal czarna malowana, MDF biały / black painted steel,  
MDF white / Schwarzstahl gestrichen, MDF weiß / черная  
сталь с окраской, MDF белый / acier noir peint, MDF  
blanche

Planet

1180x975x331



81

stal czarna malowana, MDF biały / black painted steel,  
MDF white / Schwarzstahl gestrichen, MDF weiß / черная  
сталь с окраской, MDF белый / acier noir peint, MDF  
blanche



Bezpieczeństwo  
Produkcja  
kontrolowana

www.tuv.com  
ID 900044536

April

1230x983x325



68

stal czarna malowana, MDF biały / black painted steel,  
MDF white / Schwarzstahl gestrichen, MDF weiß / черная  
сталь с окраской, MDF белый / acier noir peint, MDF  
blanche

May

1115x880x315



54

stal czarna malowana, MDF biały / black painted steel,  
MDF white / Schwarzstahl gestrichen, MDF weiß / черная  
сталь с окраской, MDF белый / acier noir peint, MDF  
blanche

July

1091x969x275



55

stal czarna malowana, MDF biały / black painted steel,  
MDF white / Schwarzstahl gestrichen, MDF weiß / черная  
сталь с окраской, MDF белый / acier noir peint, MDF  
blanche

Quaerere

1212x983x332



63,5

stal czarna malowana, MDF biały / black painted steel,  
MDF white / Schwarzstahl gestrichen, MDF weiß / черная  
сталь с окраской, MDF белый / acier noir peint, MDF  
blanche

March

1000x857x250



49

stal czarna malowana, MDF biały / black painted steel,  
MDF white / Schwarzstahl gestrichen, MDF weiß / черная  
сталь с окраской, MDF белый / acier noir peint, MDF  
blanche

Egzul

1130x973x315



68,5

stal czarna malowana, MDF biały / black painted steel,  
MDF white / Schwarzstahl gestrichen, MDF weiß / черная  
сталь с окраской, MDF белый / acier noir peint, MDF  
blanche

Ball

848,5x850x181,5



28,5



stal czarna malowana, MDF biały / black painted steel,  
MDF white / Schwarzstahl gestrichen, MDF weiß / черная  
сталь с окраской, MDF белый / acier noir peint, MDF  
blanche

June



new

wkrótce / soon / bald / скоро / bientôt



Bezpieczeństwo  
Produkcja  
kontrolowana

www.tuv.com  
ID 900044336

Wykonujemy biokominki na zamówienie według indywidualnego projektu klienta.

We produce biofireplaces according to customers individual project.

Wir fertigen biokomain auf Bestellung.

Производим биокамины под заказ по индивидуальному проекту клиента.

Nous fabriquons des bio-cheminées sur mesure, selon le projet individuel du client.



muc & scott interiors



Płyn BIO-DECO do stosowania w kominkach jako ekologiczne źródło energii. Nie wydziela zapachu, ani dymu. Został przebadany i zaaprobowany do użytkowania przez Narodowy Instytut Zdrowia Publicznego. 1 litr biopaliwa spala się od 2 do 5 godzin - w zależności od wielkości płomienia. Biopaliwo jest produktem polskim, w 100% ekologicznym.

BIO-DECO liquid is for bio fireplaces as an ecological source of energy. No odor or smoke. Has been tested and approved for use by the National Institute of Public Health. 1 liter of biofuel burns from 2 to 5 hours - depending on the size of the flame. It is a Polish product.

Der Biobrennstoff Bio-Deco geeignet für das Brennen in Kaminen als ökonomische Energiequelle. Von dem Bio-Ethanol entweicht kein Geruch und kein Qualm. Dieser Brennstoff wurde durch das Allgemeine Gesundheitsinstitut untersucht und attestiert. 1 Liter Brennstoff verbrennt innerhalb von 2 bis 5 Stunden - je nach der Flammengröße. Unser Biobrennstoff ist ein polnisches Produkt, 100% ökologisch.

Жидкость БИО-ДЕКО предназначена для использования в биокаминах. Не выделяет при сгорании запаха или дыма. Был протестирован и принят к использованию через Народowy Instytut Zdrowia Publicznego. Расход 1-го литра биотоплива от 2 до 5 часов - в зависимости от размера пламени. Биотопливо является экологически чистым продуктом (производство Польша).

BIO-DECO éthanol pour bio-cheminée est une source d'énergie écologique. Il ne dégage pas d'odeur et ne produit pas de fumée. Il a été examiné et approuvé par l'Institut National de Santé Publique. 1 litre de bio-éthanol brûle de 2 à 5h, en fonction de la grandeur de flamme.

Le biocombustible est un produit polonais, 100% écologique.



Kamienie ozdobne mogą być umieszczone zarówno w biokominkach wiszących, jak i stojących. Doskonale podkreślają ich wygląd i dodają uroku. Są odporne na wysokie temperatury. Kolor biały.

Decorative stones can be placed both in hanging and standing bio fireplaces. Decorative stones give sophisticated look and add charm. They are resistant to high temperatures. Color/white.

Die dekorativen Steine können sowohl in den hängenden als auch in den stehenden Biokaminen plaziert werden.

Sie heben das schicke Aussehen der Biokamine hervor, außerdem sind sie gegen hohe Temperaturen beständig. Farbe weiß.

Декоративные камни могут быть использованы как в настенных биокаминах, так и настольных (напольных). Отлично подчёркивают их дизайн и добавляют уюта. Устойчивы к высоким температурам. Белый цвет.

Pierres décoratives peuvent être placées aussi bien dans les bio-cheminées suspendues (à fixer au mur) que mobiles (à poser sur le sol). Les pierres accentuent l'aspect sophistiqué de la bio-cheminée et lui donnent du charme. Elles sont résistantes aux hautes températures. Couleur blanche.



Bezpieczna i funkcjonalna zapalarka z możliwością regulacji płomienia oraz napełniania gazem.

Safe and functional lighter with adjustable flame and gas filling.

Sicherer und funktionaler Anzünder, mit der Flammenregulierungsfunktion, sowie auch dem Gasnachfüller.

Безопасная и функциональная зажигалка с возможностью регулировки пламени и дозаправки газом.

Briquet pour cheminée fonctionnel et sûr, rechargeable avec du gaz; possibilité de régler la flamme.



Drewnka ceramiczne do biokominków stanowią doskonałą ozdobę, zarówno biokominków wiszących, jak i stojących. Swoim wyglądem imitują różne rodzaje drzew. Odporne na wysokie temperatury.

Ceramic piece of wood for bio fireplaces are the perfect decoration for both hanging and standing bio fireplaces. They imitate different kinds of trees.

Resistant to high temperatures.

Keramische Hölzchen für die Biokamine bilden eine ausgezeichnete Verzierung aller Biokamine. Sie ähneln den natürlichen Holzarten. Hitzebeständig.

Керамические «дрова» являются идеальным украшением как для настенных биокаминов, так и настольных (напольных).

Они имитируют разные породы деревьев. Устойчивы к высоким температурам.

Bûches décoratives en céramique pour bio-cheminées éthanol; résistantes aux hautes températures. Elles imitent les différentes essences de bois.



Pojemnik biokominka do aromaterapii

Bio container for aromatherapy

Bio-Brenner zur Aromatherapie

Контейнер биокамина к ароматерапии

Bas rectangulaire à l'éthanol pour bio-cheminée avec l'aromathérapie



**Kratki.pl Marek Bal**

ul. Warszawska 66, Wsola k. Radomia, 26-660 Jedlińsk, Poland  
tel. 00 48 48 340 10 00, 00 48 48 384 44 88, fax 00 48 48 384 44 88 wew. 106

[www.kratki.eu](http://www.kratki.eu) / [www.kratki.pl](http://www.kratki.pl)



04/2015